



---

Die schnelle und  
staubfreie Lösung  
für das Bad

---

## Mural Revela

The easy to install, decorative and  
hardwearing wall covering solution

**Gerflor**<sup>®</sup>

# Mural Revela

## A new generation of waterproof\* wall covering

Die neue Generation wasserdichter\* Wandverkleidungen



**Groove & tongue assembly**  
Nut- und Federverbindung



**Refurbishment over ceramic tiles**  
Staubfreie Renovierung direkt auf vorhandenen Fliesen



**Complete range with aluminium profiles**  
Komplettes Zubehörsortiment mit Aluminiumprofilen



≤8mm  
**Ceramic /**  
Keramische Fliesen



**XL panel size:**  
Format XL Paneel:  
90 × 260 cm



**XXL panel size:**  
Format XXL Paneel:  
120 × 260 cm



**Tile size:**  
Format Fliese:  
65 × 37,5 cm

## Mural Revela

### Packaging

	Tiles / Fliese		XL panel / XL Paneel		XXL panel / XXL Paneel	
	Matt	Gloss	Matt	Gloss	Matt	Gloss
Number of tiles / panels per box	8		2		1	
m <sup>2</sup> / box	1,95		4,68		3,12	
Weight of the box (kg)	±13,5	±15	±36	±39	±25	±30
number of boxes per pallet	48		10		20	
m <sup>2</sup> / pallet	93,6		46,8		62,4	

**All designs are available in the below formats**  
Dekore sind in unterschiedlichen Formaten erhältlich



**Tile size:**  
Fliese:  
65 × 37,5 cm



**XL panel size:**  
XL Paneel:  
90 × 260 cm

**Designs / Die Dekore:**  
Kamina, Alanya,  
Ubeda, Tanami Gloss  
**are available in format /**  
sind auch erhältlich im Format



**XXL panel size:**  
XXL Paneel:  
120 × 260 cm



### Waterproof product\* - Wasserdicht\*

- **Water resistant**
- **Washable product**
- **Installation in shower and/or bathtub area**

- Wasserbeständig
- Abwaschbar, besonders pflegeleicht
- Verwendung im Nassbereich (Dusche / Badewanne)



### Easy and quick to install

Einfache und schnelle Montage

- **Lightweight product that is easy to cut**
- **Can be installed in a third of the time it would take to install ceramic tiles**
- **The room's first use can be within 24 hours**

- Leichtes Produkt und einfacher Zuschnitt
- Nut- und Federverbindung, ohne Verfugen
- Dreimal schneller verarbeitet als klassische Wandfliesen



### Suitable for all surfaces

Für Renovierung und Neubau

- **Glue-down installation**
- **Suitable for new builds**
- **Refurbishment over existing ceramic tiles**

- Geeignet für verschiedene Untergründe
- Direkte Verklebung auf vorhandenen Fliesen
- Verarbeitung mit Klebstoff



### Super realistic design

Ultrarealistische Designs

- **Matte or glossy designs**
- **Tile and XL/XXL panel sizes**
- **Extra-thin joints**
- **Perfectly matched to Gerflor flooring**

- Matt- und Glanzdekore
- Fliesen und XL/XXL-Paneele
- Extra schmale Fugen



### Durable design

Robuster Produktaufbau

- **Groove/tongue assembly**
- **Rigid product**

- Strapazierfähig
- Stabile Verriegelung



### Full range - Passendes Zubehör

- **Aluminium profile design, glue and sealant**
- Alu-Designprofile, Kleb- und Dichtstoff



### Circularity - Zirkularität

- **Reach compliant**
- **Recyclable through the Second Life Program**
- **Contains up to 30% recycled products**
- **EPD available**

- Absolut wohngesund, 100 % REACH-konform
- Recyclbar über das Second Life Programm
- Produziert mit bis zu 30 % Recyclinganteil
- EPD verfügbar

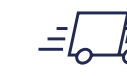

### 100% in stock

100 % auf Lager



### Made in Belgium

Produziert in Belgien

\* Respecting the Gerflor installation guidelines  
\* Bitte beachten Sie die Montageanleitung auf gerflor.de

Vilnius

**Mural Revela,**  
The complete wall covering  
solutions with matching finishing  
profiles for a stylish result.

Die komplette  
Wandverkleidungslösung mit  
passenden Abschlussprofilen  
für ein stilvolles Ergebnis.

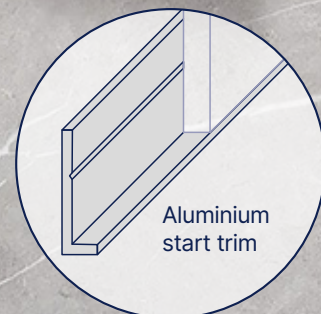
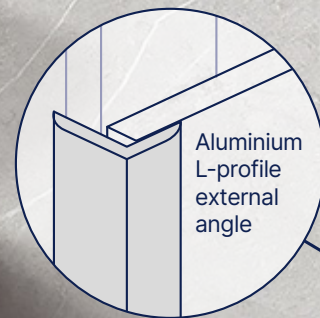
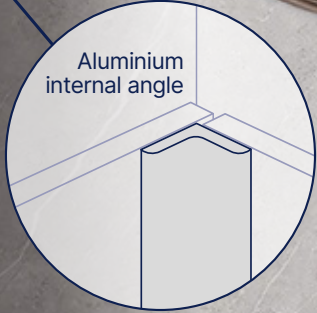

Concrete Cream / Wood Clear



## From floor to wall

Create harmony between  
our floors and walls.

# Mural Revela

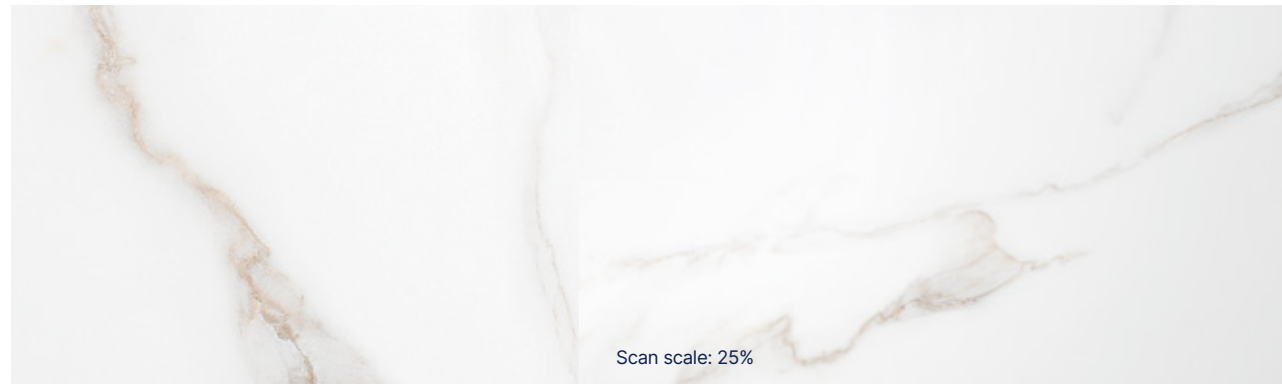

Scan scale: 25%

7029 Tanami Gloss  
NCS: 0804-R70B / LRV: 63.2

65 x 37,5 cm 90 x 260 cm

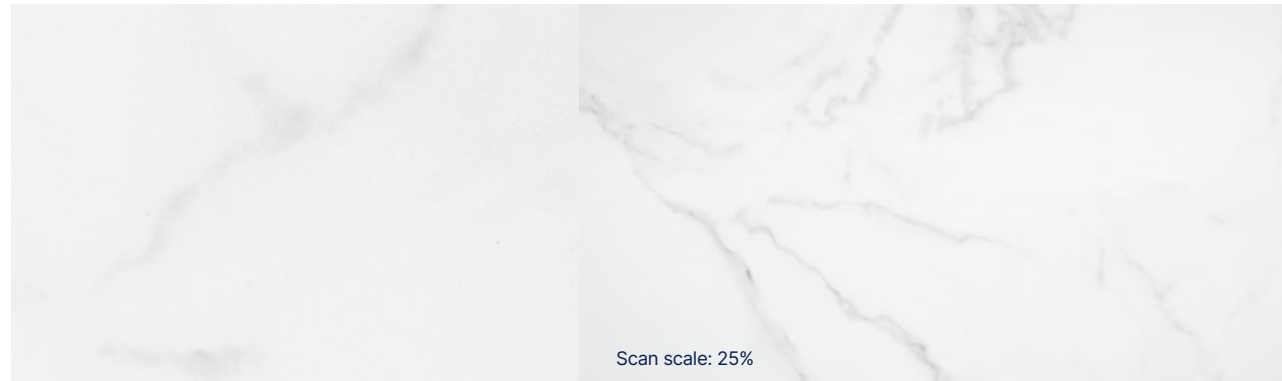

Scan scale: 25%

7093 Ampara  
NCS: 1002-B50G / LRV: 72.2

65 x 37,5 cm 90 x 260 cm



7059 Derby Gloss  
NCS: 1002-B50G / LRV: 66.9

65 x 37,5 cm 90 x 260 cm



Derby Gloss

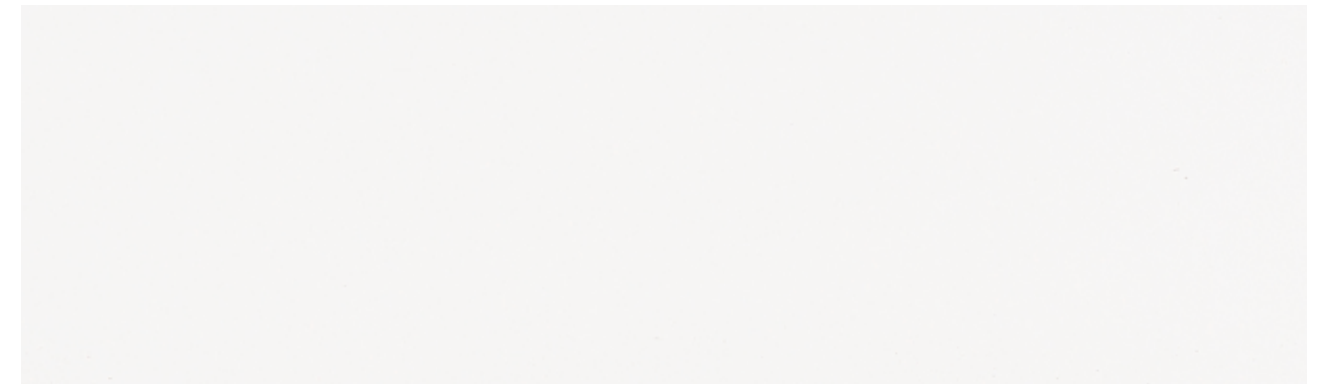

7918 Hanoi  
NCS: 0603-G40Y / LRV: 80.8

65 x 37,5 cm 90 x 260 cm



Marmor White

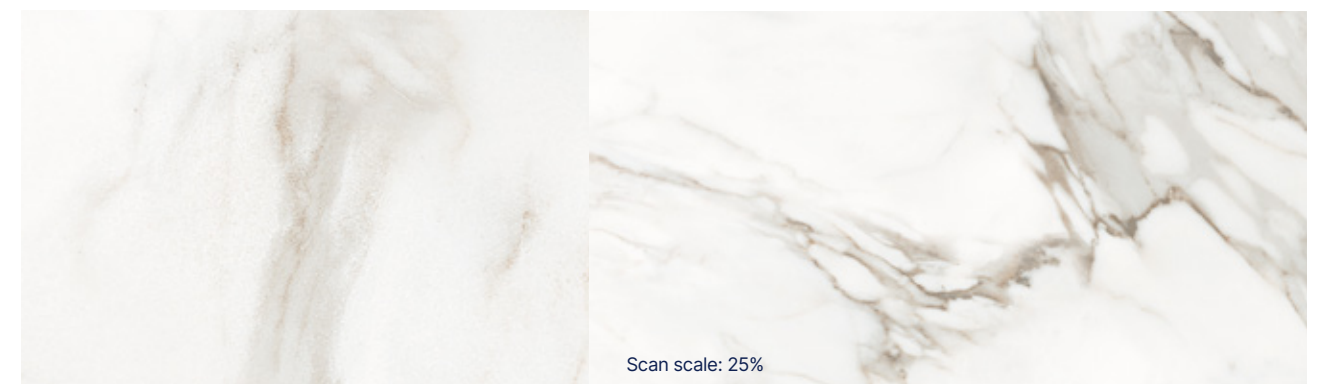

Scan scale: 25%

7099 Marmor White  
NCS: 1002-B50G / LRV: 75.5

90 x 260 cm



7053 Zanzibar  
NCS: 2005-Y80R / LRV: 48.6

65 x 37,5 cm 90 x 260 cm



7097 Boulia Gloss  
NCS: 2005-Y50R / LRV: 49.2

65 x 37,5 cm 90 x 260 cm



7100 Terrazzo Cobalt  
NCS: 1002-Y / LRV: 66.4

65 x 37,5 cm

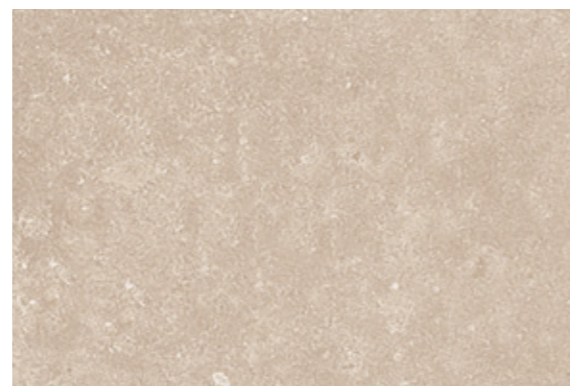

7102 Concrete Cream  
NCS: 2005-Y30R / LRV: 49.7

65 x 37,5 cm

# Mural Revela



7035 Corabia  
NCS: 2005-Y50R / LRV: 46.1

65 x 37,5 cm 90 x 260 cm



7869 Baeza  
NCS: 4005-Y50R / LRV: 28.2

65 x 37,5 cm 90 x 260 cm



7095 Travertine Bone  
NCS: 2002-Y30R / LRV: 54.6

65 x 37,5 cm 90 x 260 cm



7096 Wood Clear  
NCS: 3020-Y20R / LRV: 38.8

65 x 37,5 cm 90 x 260 cm

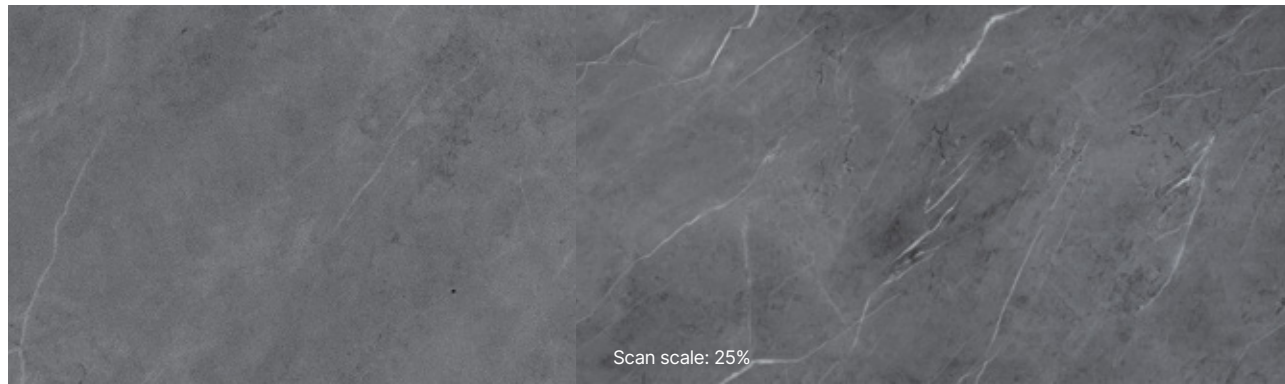

7052 Colima  
NCS: 7000-N / LRV: 11.9

65 x 37,5 cm 90 x 260 cm



7007 Vilnius  
NCS: 3000-N / LRV: 43.5

65 x 37,5 cm 90 x 260 cm

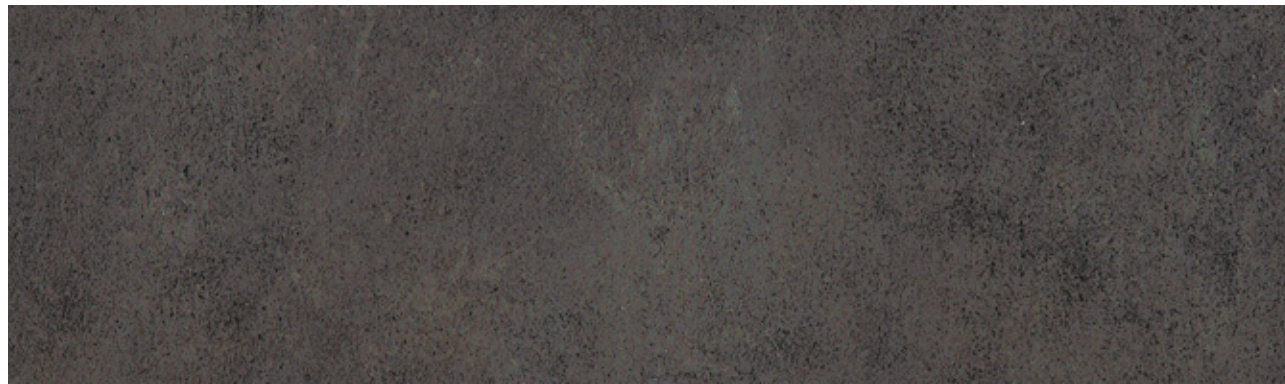

7032 Alanya  
NCS: 6502-R / LRV: 11.0

65 x 37,5 cm 90 x 260 cm / 120 x 260 cm

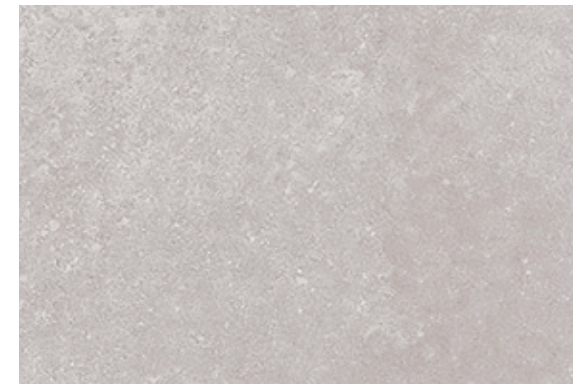

7101 Concrete Clear  
NCS: 3500-N / LRV: 39.5

65 x 37,5 cm



7868 Ubeda  
NCS: 1502-G50Y / LRV: 62.2

65 x 37,5 cm 90 x 260 cm / 120 x 260 cm

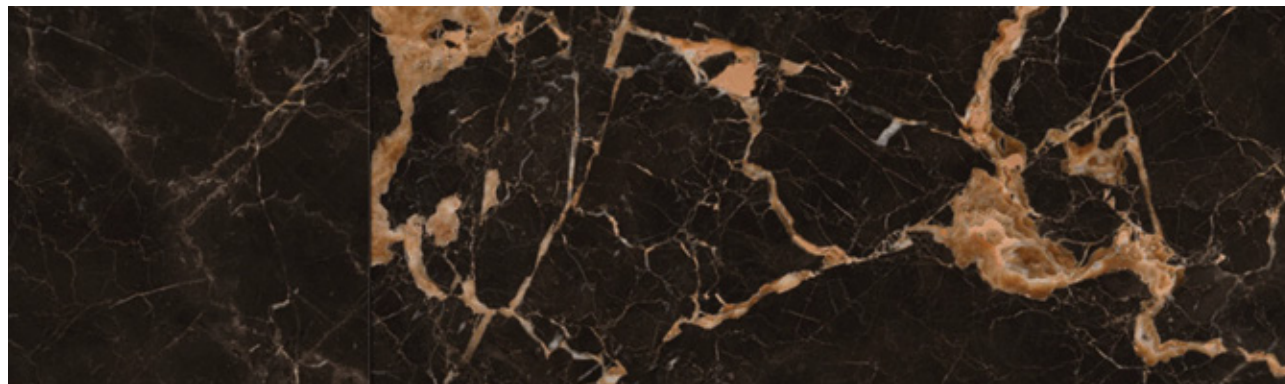

7098 Marbre Noir Gloss  
NCS: 9000-N / LRV: 1.8

90 x 260 cm



7915 Kampala  
NCS: 3500-N / LRV: 36.4

65 x 37,5 cm 90 x 260 cm



7091 Kamina  
NCS: 3000-N / LRV: 40.7

65 x 37,5 cm 90 x 260 cm / 120 x 260 cm

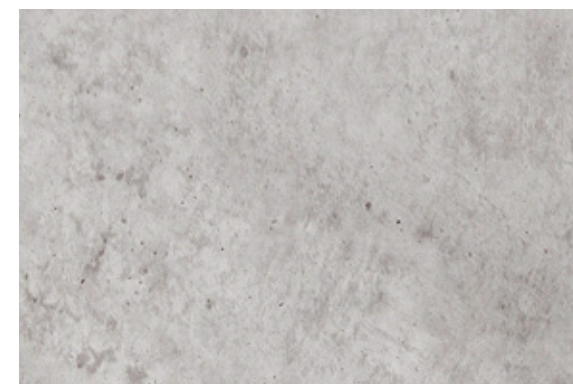

7911 Liverpool  
NCS: 3000-N / LRV: 41.5

65 x 37,5 cm 90 x 260 cm



7072 Sarti  
NCS: 2000-N / LRV: 55.9

65 x 37,5 cm 90 x 260 cm







Mural Revela						
			Tile / Fliese	Panel / Paneele XL/XXL		
Description / Beschreibung			Matt	Gloss	Matt	Gloss
Total Thickness / Gesamtdicke	NF EN ISO 24346	mm	5			
Weight / Flächengewicht	NF EN ISO 23997	g/m <sup>2</sup>	6750	7500	6750	7500
Size / Format	NF EN ISO 24341	cm	65 × 37,5		90 × 260 / 120 × 260	
Chanfrein / Fase	-	-	Yes / Ja		No / Nein	
Phtalate free / Phtalatifrei	-	-	Yes / Ja		Yes / Ja	
Classification / Klassifikation						
Norm/Product Specification / Produktnorm	-	-	EN 15 102			
Fire Rating / Brandverhalten	EN 13501-1	class / Klasse	D-s3,d0			
Performances / Technische Eigenschaften						
Surface Treatment/ Oberflächenvergütung	-	-	OK			
Cleanability / Reinigung	EN 233	-	Washable / Abwaschbar*			
Environment / Umwelt						
Recycled content / Recyclinganteil	-	%	Up to 30 / Bis zu 30			
Recyclability / Recyclenbar	-	-	Yes / Ja			
EPD	-	-	Available / Verfügbar			
Health / Raumluftqualität						
TVOC after 28 days / TVOC (28 Tage)	ISO 16516	µg/m <sup>3</sup>	< 100			
CE Marking / CE Kennzeichnung						
	EN 15102	-	OK			

\* Finishes, installation and maintenance guidelines: available on demand.

Bitte beachten Sie die ausführliche Pflege- und Montageanleitung auf [www.gerflor.de](http://www.gerflor.de)

**IMPORTANT:** The information contained in this document is valid from 01/07/2026 and is subject to change at any time without notice. In the context of constantly changing technology, our customers are responsible, prior to any use, for checking with us that this document is the version in force.

## we care / we act our commitments for 2030

 <b>climate</b>	 <b>resources</b>	 <b>circularity</b>	 <b>health &amp; well-being</b>	 <b>people</b>
<b>-30% CO<sub>2</sub></b> scopes 1, 2, 3 in tons eq. CO <sub>2</sub> vs 2019 Science Based Targets <sup>(1)</sup>	<b>75%</b> biobased, mineral and recycled content <sup>(2)</sup>  <b>30%</b> recycled content <sup>(3)</sup>	<b>65 000 tons</b> annual volume recycled <sup>(4)</sup>  <b>45%</b> looselay <sup>(5)</sup>	<b>100%</b> products better than Indoor Air Quality standards <sup>(6)</sup>  <b>95%</b> sales covered by EPD <sup>(7)</sup>	<b>30%</b> women <sup>(8)</sup>  <b>40%</b> internal mobility <sup>(9)</sup>  <b>Towards 0</b> accident <sup>(10)</sup>

**More details:** 1. Scopes 1, 2 & 3, in absolute value, market-based. Trajectory approved by SBTi (Science Based Targets Initiative). 2. Origin of raw materials for the entire Floor & Wall portfolio, on average, by weight; including 15% virgin salt, a primary element in vinyl manufacturing. Compared to 71% in 2024. 3. Average content in the Floor & Wall vinyl portfolio, by weight. Compared to 21% in 2024. 4. Recycled in our factories and recycling units. Compared to 59 040 tons in 2024. 5. % of Floor activity with non-glued products, easy to remove, easy to re-use. Compared to 40% in 2024. 6. 100% of vinyl and linoleum sold to the building market below 100 micrograms / m<sup>3</sup> (TVOC 28 days). 7. % of Floor & Wall activity covered by Environmental Product Declarations (EPD). Compared to 44% in 2024. 8. % women in our global workforce and among our managers. Compared to respectively 26% and 27% in 2024. 9. % job openings filled with internal hires worldwide. Compared to 25% in 2024. 10. Towards 0 accident: Lost time accident per million hours worked: below 3 vs 8,9 in 2024, for Gerflor employees worldwide.

